

HTW76

Series
Actuators

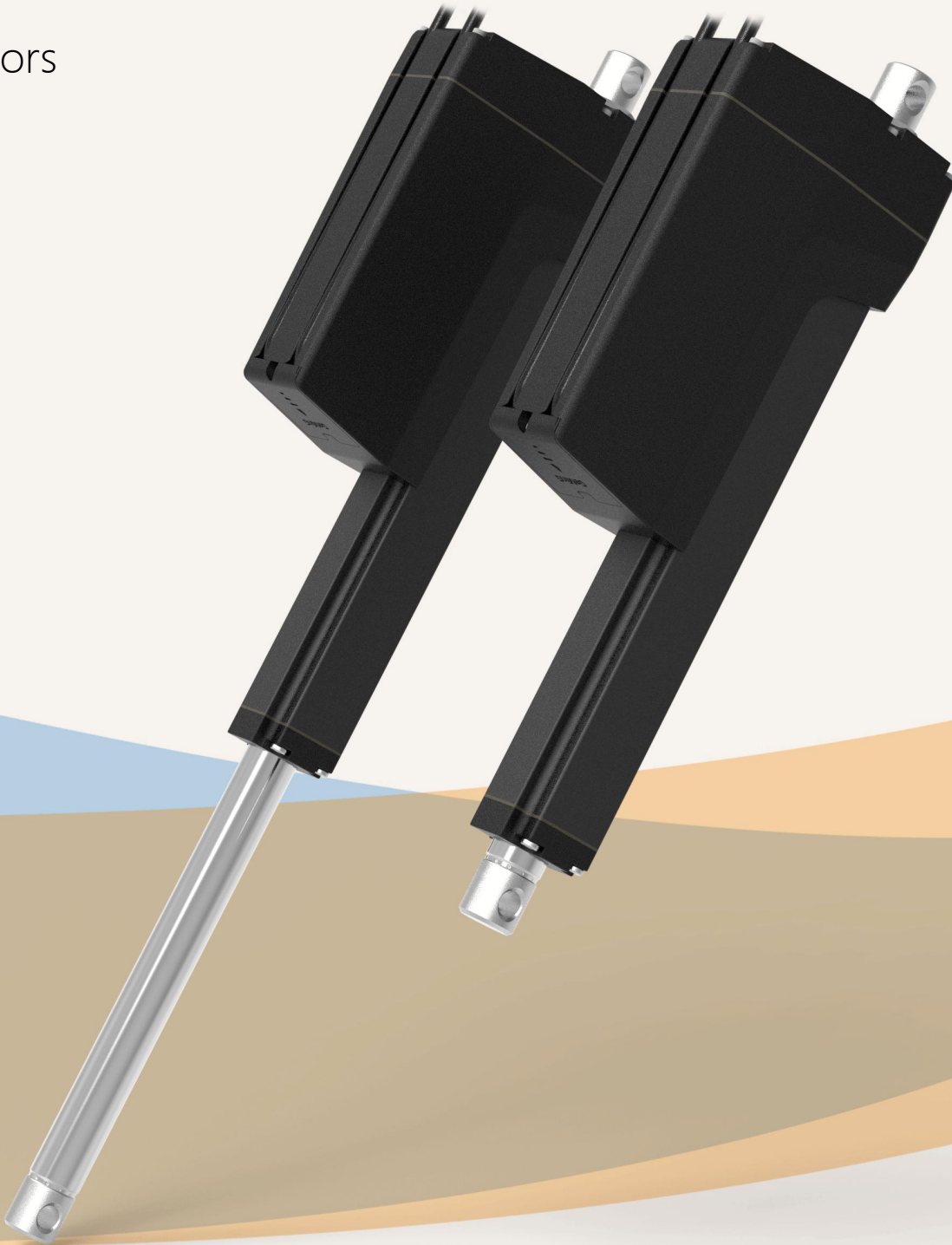

HTW76

Series

Linear Actuators

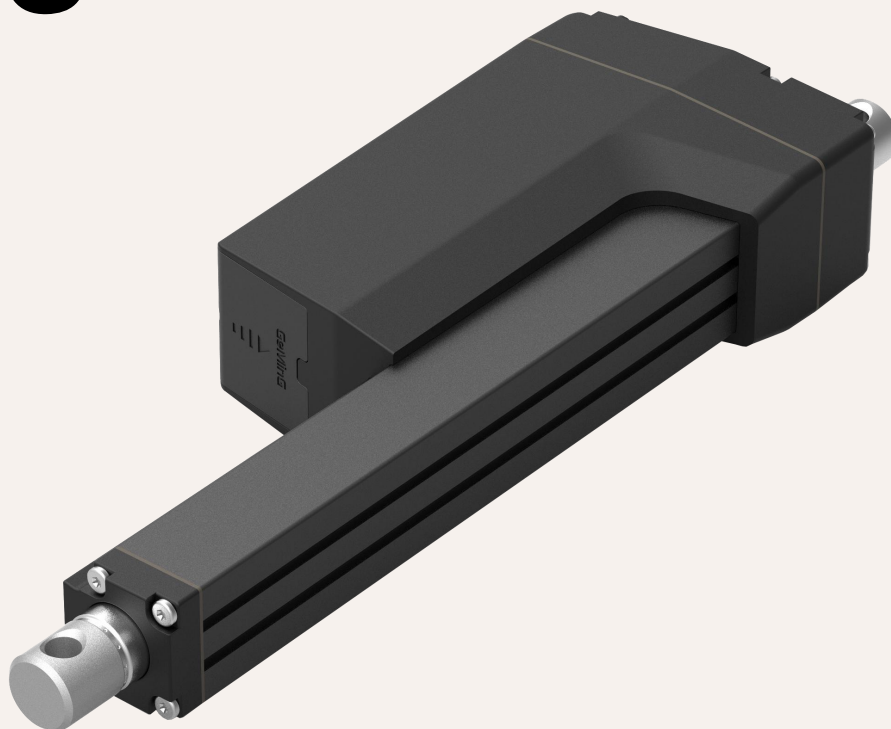

Product Category

- 1、 Industrial application
- 2、 Military application
- 3、 Agricultural machinery

HTW76 is a push rod specially designed for harsh industrial environments. It is especially suitable for some mechanical equipment with high consumption, such as agricultural machinery and industrial application equipment. If you're looking for an actuator that can be used in harsh industrial environments and meet strict specifications, smart electromechanical actuators feature on-board electronics that eliminate the need for a separate control system. With higher power up to 16 kN, it opens up more possibilities for hydraulic steering electric applications. HTW76 will be the best choice

Functional Overview

Voltage:	12V, 24V, 36V, 48V DC
Motor options:	DC motor, brushless DC motor
Maximum thrust (pull force):	16,000N / 14,000N
Slowest speed under load:	5.0mm/s (load 16,000N)
Maximum speed under load:	83 mm/s (load 1,000N)
Minimum installation size:	Stroke + 250mm
Dynamic lateral moment:	1,000Nm
Static lateral moment:	800Nm
color:	Silver gray, black
Voice:	60~68 DB
Adaptable temperature range:	-45°C ~ +75°C
Protection level:	IP66
Screw selection:	I ball screw, trapezoidal screw
Switch type:	Built-in limit switch,
Signal options:	Potentiometer, Hall sensor, endpoint signal
Control options:	Synchronous control, independent control,
safety certificate:	integrated control, CAN bus control,
	Comply with ISO9001-2008,
High-strength metal zinc alloy gearbox and housing,	CE and RoHS regulations,

Electrical conversion trend accelerates

Easier installation, better control and less complexity

Installation is simpler, smaller and faster

Easier control and greater precision

Electric execution requires fewer components and is faster and easier

to install than hydraulic or pneumatic systems

- Component costs are lower than comparable cost hydraulic or pneumatic systems
- Smaller footprint simplifies and speeds design

Easier control and greater precision

- Fully electrical components mean easier integration, fewer control components and less complexity
- Electric actuators react faster, more predictably, and won't drift when power is turned off

Reduce energy costs

- Electric motors are inherently more efficient than pneumatic or hydraulic motors
- Consider potential parasitic power consumption without scaling up existing systems
- No need for any power supply to maintain load reducing power consumption

Reduce maintenance

- No use of hydraulic pumps, valves or hoses to reduce downtime, repair parts and replacement
- Stand-alone device electronics with smart onboard equipment requiring zero maintenance and increasing design flexibility for component placement
- Electric execution eliminates the cost and hassle associated with fluid maintenance

NEW!

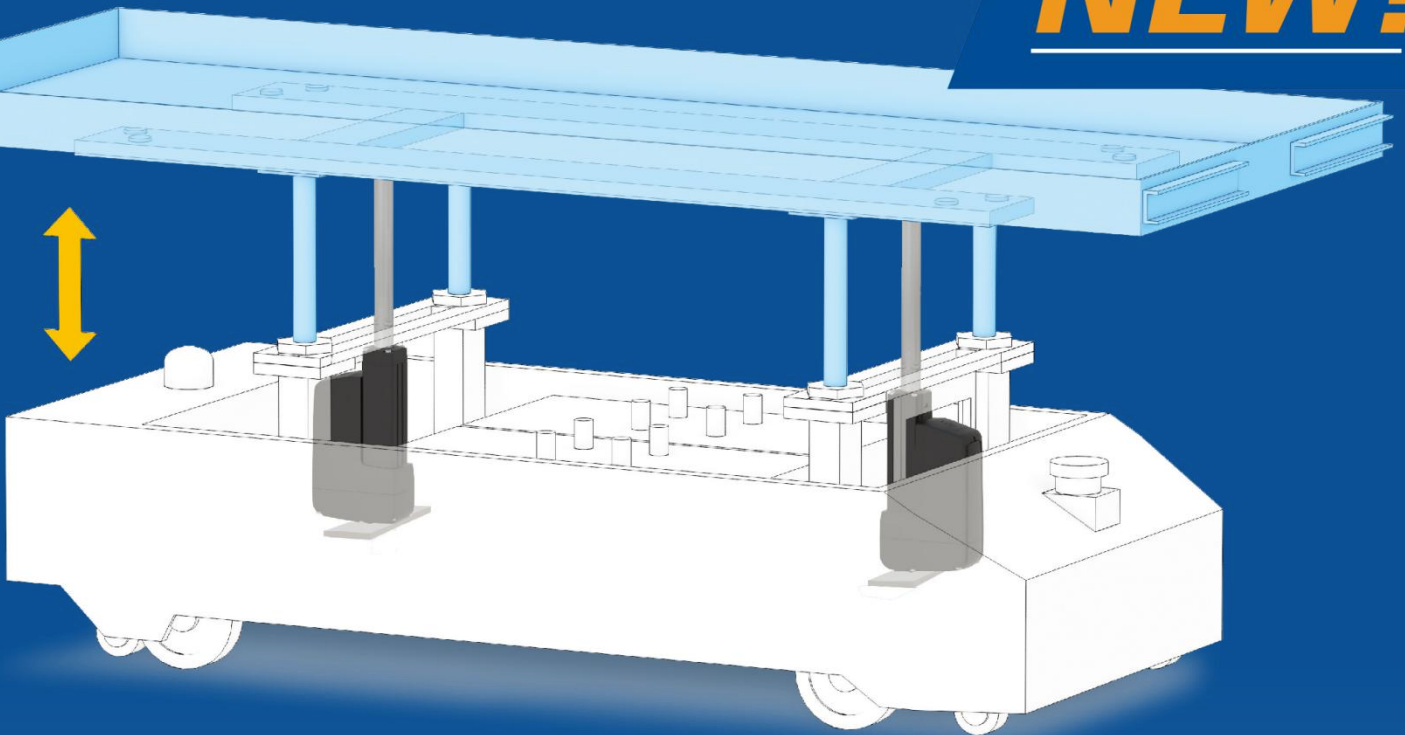

Rear installation can be retrofitted with flange installation

Electric linear actuators for automated guided vehicles, mobile equipment and industrial automation

height adjustment

Positioning adjustment

More compact design,

making it easier to install in small spaces,

Very suitable for designing different types of automation equipment,

unmanned trucks and lifting equipment,

All while retaining many of the benefits that make it so popular!

Drawings

Standard size
MM

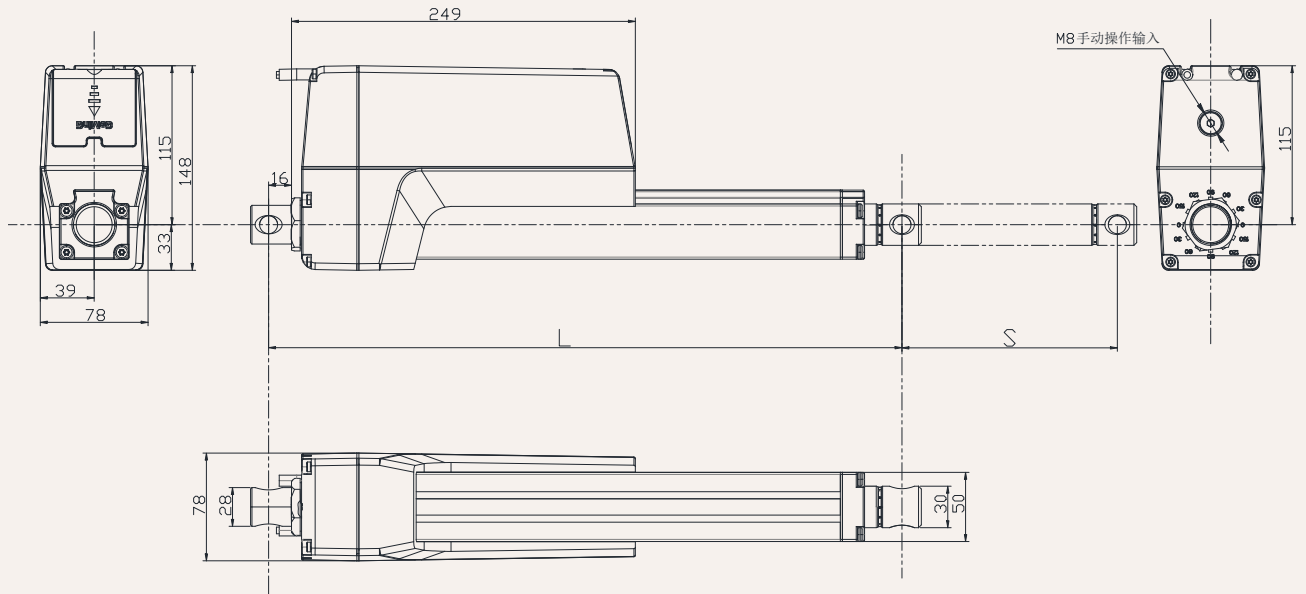

S: Stroke

L: Retracted length

L = Stroke + 250mm

Greater than 600MM stroke, installation dimensions L = Stroke + 300MM

Installation angle (counterclockwise):

0 = 0 Degrees

9 = 90 Degrees

G = Adjust at will

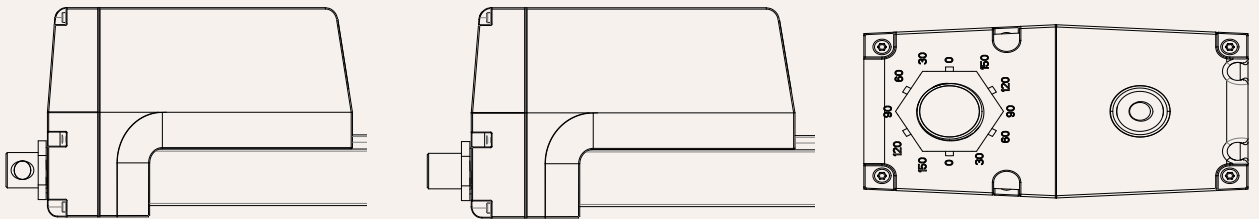

load and speed

Code	Rated load Thrust N	Pull N	Self-locking force static conditions static N	Rated load current A	Output speed no load 24V DC mm/s	Rated load 24V DC mm/s
Motor voltage (24V DC)						
A	16,000	14,000	25,000	18.3	5.0	4.0
B	14,000	14,000	25,000	18.3	7.0	6.0
C	11,000	11,000	15,000	18.3	9.0	7.0
D	7,100	7,100	7,100	18.3	15	12
E	6,500	6,500	6,500	18.3	19	15
F	4,200	4,200	4,200	18.3	29	23
G	3,600	3,600	3,600	18.3	33	26
H	2,700	2,700	2,700	18.3	44	35
I	1,800	1,800	1,800	18.3	66	53
J	1,200	1,200	1,200	18.3	100	80
K	750	750	750	18.3	130	100

Remark

1. The speed and current on the upper side are the materials that extend when pushed.
2. For 12V motor, the speed is about the same and the current is about 2 times higher.
3. The current & speed in the table are the test average values in the extension direction under thrust application.
4. The current & speed in the table and graph are the test average values of the GeMinG control box configuration, and there is an error of about 10% depending on the control box model.
(The voltage is about 29V DC at no load, and drops to about 24V DC at rated load)

Stroke: minimum value $\geq 20\text{mm}$, please refer to the table below for the maximum value of load and stroke

load (N)	Maximum stroke (mm)
16,000	50-200
15,000	201-300
12,000	301-400
7,000	401-600
6,000	601-900

Remark:

Lateral moment Y direction = $X \times 0.8$

Static lateral moment = dynamic $\times 2$

Dynamic lateral moment (Nm)-X direction

stroke	S+250	S+300
100-200	200	300
300-500	150	250
500-700	100	200
700-900	80	100

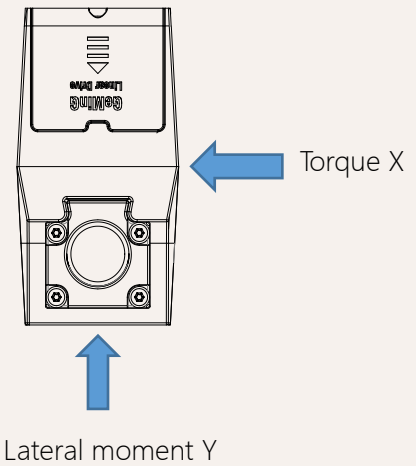

Stroke installation size reference chart

HTW76 Series	stroke ± 2 (mm)					Install ± 2 (mm)				
strokeMM	100	150	200	250	300	350	400	450	500	
Install MM	350	400	450	500	550	600	650	700	750	
weight KG	8.5	8.8	9.1	9.4	9.7	10.1	10.5	10.9	11.5	

Actuator wiring diagram

No signal feedback wiring diagram

Code: N

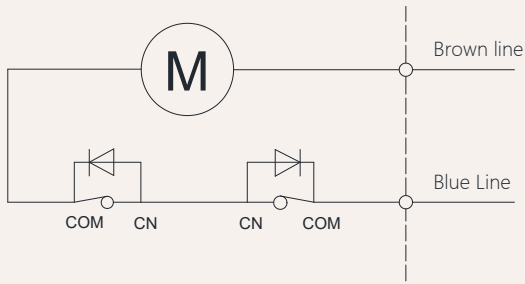

Wiring Instructions:

- 1] Brown lead: motor positive +
- 2] Blue lead: motor negative pole -
- 3] When the push rod is extended: the brown wire is positive +, the blue wire is negative -
- 4] When the push rod is retracted: the blue line is positive +, the brown line is negative -

Actuator wiring diagram Built-in control module

Built-in controller wiring diagram

Code: NY

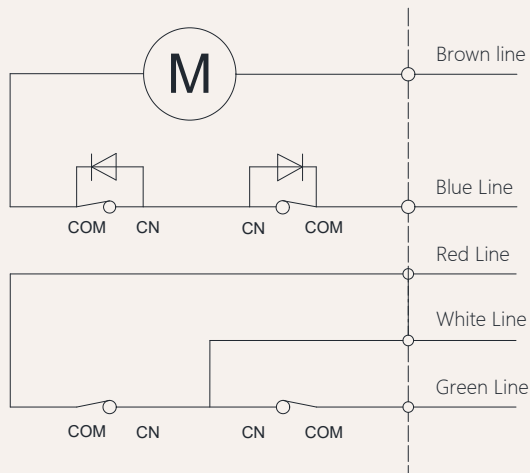

Wiring Instructions:

- 1] Brown lead: motor positive +
- 2] Blue lead: motor negative pole -
- 3] When the push rod is extended: white line + red line
- 4] When the push rod retracts: white line + green line
- 5] White line: control output common line.
- 6] White and red lines: stretch out,
- 7] White and green lines: retract,
- 8] Wireless remote control, use wired control simultaneously.

Other signal descriptions

Feedback signal	Description	Function
Active endpoint feedback signal	Voltage with this model	When the push rod reaches the end point, a signal will be fed back. This signal will always exist and will disappear during the operation of the push rod., When the push rod reaches the end point, it will feedback a signal. This signal always exists when the input power is not turned off. When the input power is turned off, the signal disappears. The signal will also disappear during the operation.
Passive endpoint feedback signal	No voltage	

Note: For other needs, please contact the GeMinG team

Signal feedback **Passive or active**

Passive or active endpoint signal wiring diagram

Code: N passive signal, Code: Y active signal

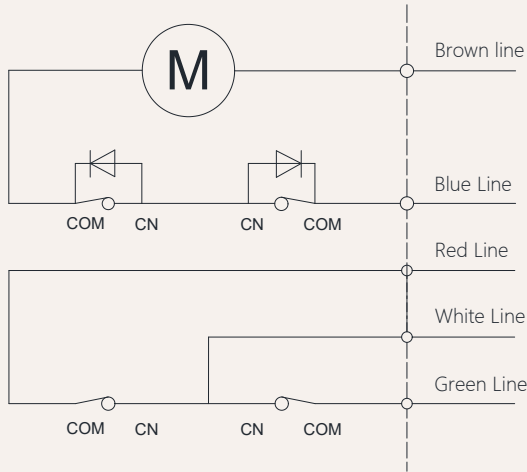

Wiring Instructions:

- 1] Brown lead: positive pole of motor +
- 2] Blue lead: negative pole of motor -
- 3] When the push rod is extended: brown wire positive pole +, blue wire negative pole -
- 4] When the push rod is retracted: blue wire positive pole +, brown wire negative pole -
- 5] White wire: signal output common line.
- 6] White and red wire: extension end signal,
- 7] White and green wire: retraction end signal,

Signal feedback **Potentiometer**

Potentiometer wiring diagram

Code: K

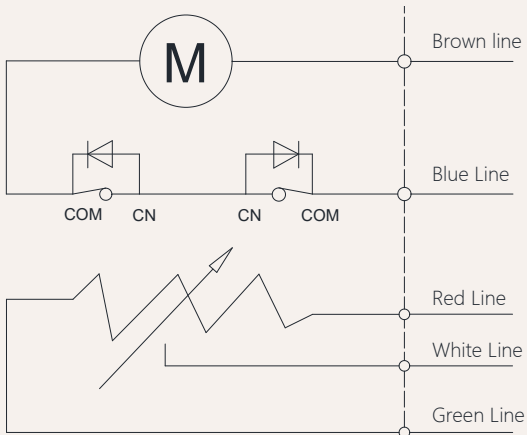

Wiring Instructions:

- 1] Brown lead: positive pole of motor +
- 2] Blue lead: negative pole of motor -
- 3] When the push rod is extended: brown wire positive pole +, blue wire negative pole -
- 4] When the push rod is retracted: blue wire positive pole +, brown wire negative pole -
- 5] White and yellow leads: variable resistance signal output.
- 6] When the push rod is extended: red and white leads-resistance value gradually increases,
-----red and yellow leads-resistance value gradually decreases.
- 7] When the push rod is retracted: red and white leads-resistance value gradually decreases,
-----red and yellow leads-resistance value gradually increases.

Potentiometer Configuration Form

Transmission Code

Limit travel range

Resistance range unit (KΩ)

(See page 5)

A,C,E,G

50-350MM

50-200Stroke range5.0

50-300Stroke range7.5

B,D,F

50-550MM

50-200Stroke range3.17

50-400Stroke range6.35

Note: Potentiometer resistance is 10KΩ, actual output resistance depends on specific stroke

Signal feedback Hall sensor

Hall signal motor circuit diagram

Code: H

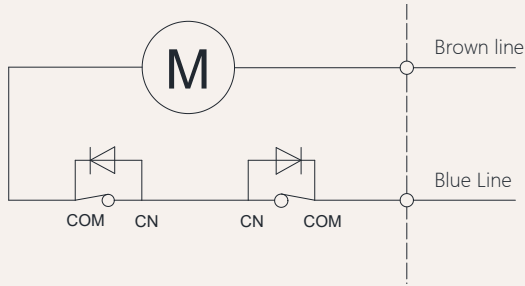

Hall signal output waveform diagram

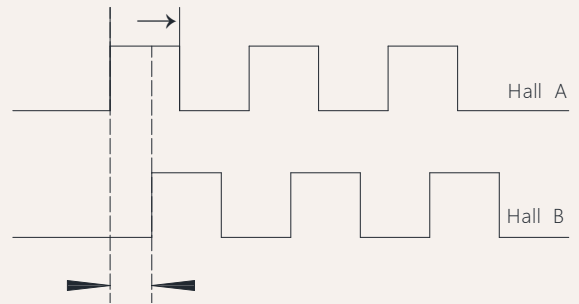

Schematic diagram of the internal circuit of the Hall signal

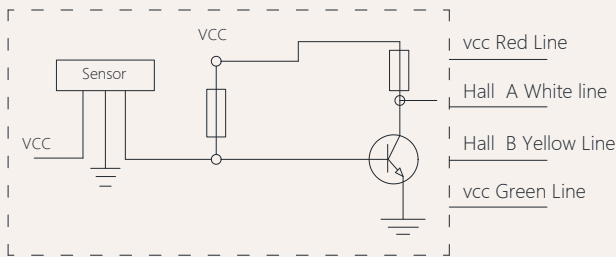

Wiring Instructions:

- 1] Brown lead: positive pole of motor +
- 2] Blue lead: negative pole of motor -
- 3] Red lead: VCC 5V voltage input +
- 4] Green lead: GND 5V voltage input -
- 5] White lead: Hall signal output A
- 6] Yellow lead: Hall signal output B

Notes:

- 1) Support dual-channel/single-channel Hall encoder
- 2) Current-consuming digital output
- 3) High-speed response frequency from: 0 KHz-100 KHz
- 4) Applicable temperature range:-40 °C~+125 °C

Characteristics	Symbol	Test conditions	MI	RE	M	Unit
Supply voltage	Vcc	----	3.5	---	24	V
Output saturation voltage	Vce/sat	Vcc=14V ; Ic=20mA	---	300	700	MV
Output leakage current	1 cex	Vce=14V ; Vcc=14V	---	<0	10	UA
Input voltage	1 ce	Vcc=20V ; Output open	---	1	10	M
Output fall time	R	Vcc=14V ; RL=820Ω ; CL=20pF	---	0.3	1.5	US

Signal feedback CAN bus

CAN Communication motor circuit diagram

Code: CN

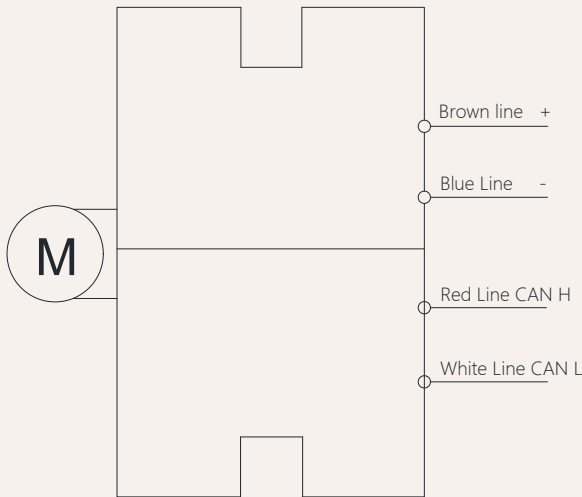

Wiring Instructions:

- 1] Brown lead: positive pole of motor +
- 2] Blue lead: negative pole of motor -
- 3] Red lead: CAN H
- 5] White lead: CAN L

Note:

1. The brown and blue power cables cannot be reversed, otherwise the driver may be burned.
2. With CAN bus, excluding Terminal resistor: in compliance with J1939
3. Speed: Baud rate: 500kbps
4. Wiring shielded twisted pair

CAN Control instructions

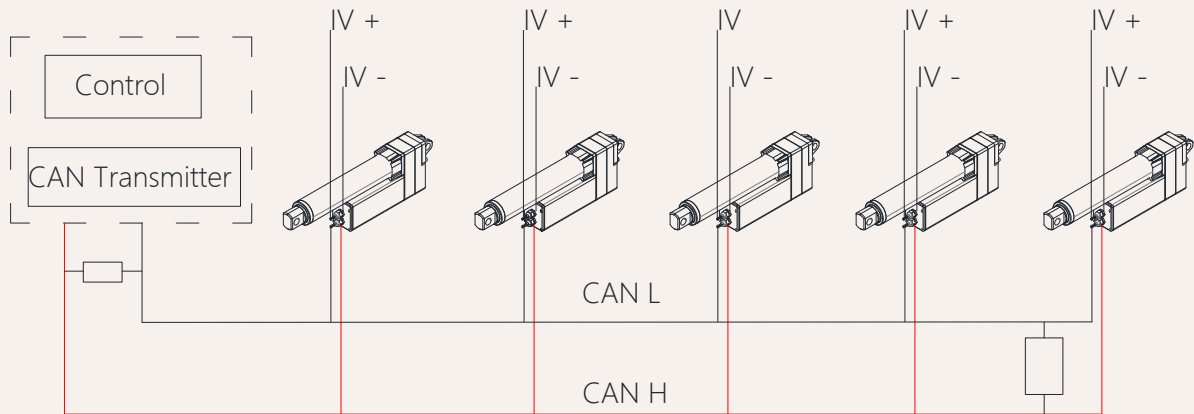

HTW76 Model Description Selection Code Table

HTW76 - 24 - A - 100 - 250 - O2 - O2 - 0 - 1 - T - A - N - 07
 ① ② ③ ④ ⑤ ⑥ ⑦ ⑧ ⑨ ⑩ ⑪ ⑫ ⑬

①	Product number	HTW76			
②	Voltage	12=12V DC	24=24V DC	36=36V DC	48=48V DC
③	Load(n)@Speed (mm/s)	See page 06			
④	Stroke(mm)	See page 06			
⑤	Installation size(mm)	Note: Before selecting a size, please refer to the valid data sheet! See page 05			
⑥	Upper type See page 13	O1 =Conventional ordinary type, hole diameter12.5mm U1 = U-shaped, groove width 10.5mm, hole diameter 12.5mm M1 = Type M, M16 thread, depth 20 mm T1 = T-type, M16 thread, length 20mm L1 =L shape, width 20mm, aperture 12.5mm G1 = Spherical bearing, bore 14mm, model GS14	O2 = Conventional ordinary type, hole diameter 13.5mm U2 = U-shaped, groove width 10.5mm, hole diameter 13.5mm M2 = MType M, M18 thread, depth20 mm T2 = T-type, M18 thread, length 20mm L2 = L shape, width 20mm, aperture 13.5mm G2 = Spherical bearing, bore 16mm, modelGS16		
⑦	lower type See page 14	O1 =Conventional ordinary type, hole diameter2.5mm U1 = U-shaped, groove width 10.5mm, hole diameter 12.5mm M1 = Type M, M16 thread, depth 20 mm T1 = T-type, M16 thread, length 20mm L1 =L shape, width 20mm, aperture 12.5mm G1 = Spherical bearing, bore 14mm, model GS14	O2 = Conventional ordinary type, hole diameter 13.5mm U2 = U-shaped, groove width 10.5mm, hole diameter 13.5mm M2 = MType M, M18 thread, depth20 mm T2 = T-type, M18 thread, length 20mm L2 = L shape, width 20mm, aperture 13.5mm G2 = Spherical bearing, bore 16mm, modelGS16		
⑧	Installation angle (counterclockwise)	0 =0°, Degree		9 =90°, Degree	
⑨	Please refer to the outlet type	1 = Dare wire 4 = Four-pin straight plug 7 = Waterproof plug		2 = 01 Straight plug 6 = Six-pin straight plug 0 = Customized	
⑩	Lead screw options	T = Trapezoidal screw (default preferred)		G= Ball screw rod	
⑪	Control method	A = No Control	NY =Integrated wired control NW=Integrated wireless control	NT = Synchronous control NC = CAN bus	D= Customized
⑫	Signal output options	N = No	H =Hall sensor	D = Potentiometer	W=passive signal U=active signal
⑬	Cable length	07 = 700mm 30 = 300mm	10 = 1000mm 40 = 4000mm	15 = 1500mm 70 = 7000mm	20= 2000mm 00 =Customized

HTW76 Attachment Description Selection Code Table

Extended upper form:

O1=No slot, aperture 12.5MM

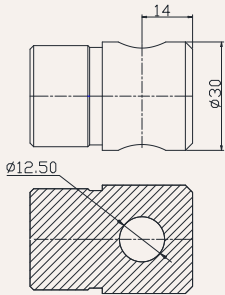

O2=No slot, aperture 13.5MM

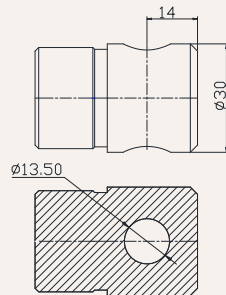

U1 = U-shaped, groove width 10.5mm, hole diameter 12.5mm

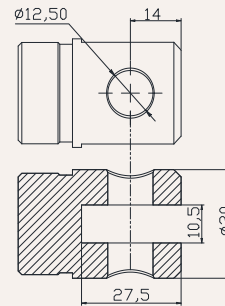

U2 = U-shaped, groove width 10.5mm, hole diameter 13.5mm

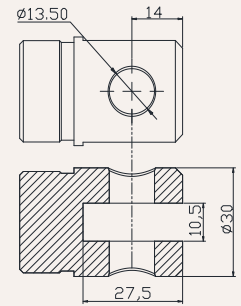

M1 = Type M, M16 thread, depth 20 mm

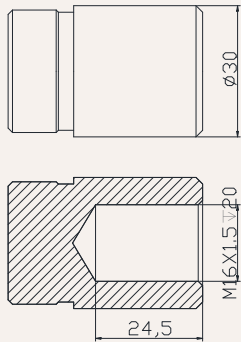

M2 = Type M, M18 thread, depth 20 mm

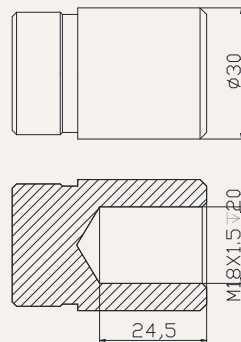

T1 = T-type, M16 thread, length 24mm

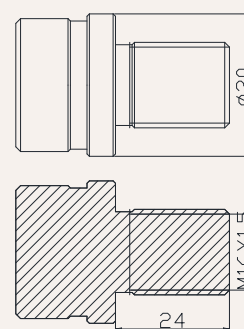

T2 = T-type, M18 thread, length 24mm

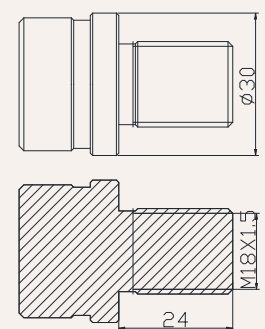

L1 = L shape, width 20mm, aperture 12.5mm

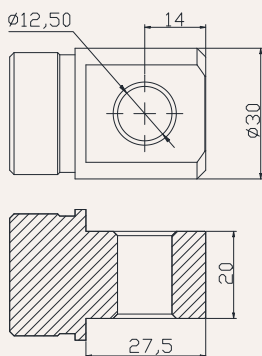

L2 = L shape, width 20mm, aperture 13.5mm

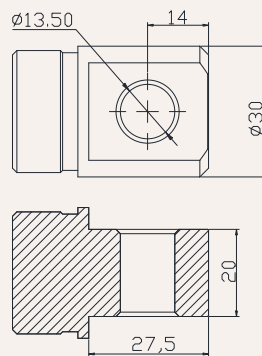

G1 = Spherical bearing, bore 12mm, model GS12

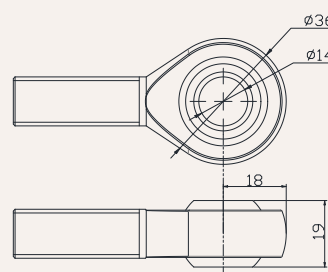

G2 = Spherical bearing, bore 14mm, model GS14

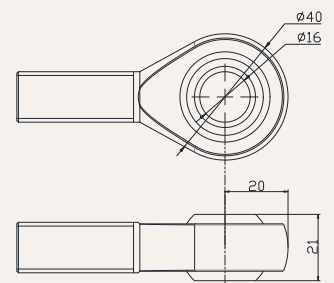

Power cord type:

1 =Dare wire

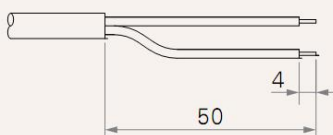

2 = 01 Straight plug

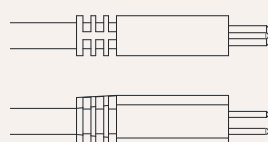

4 =Four-pin straight plug

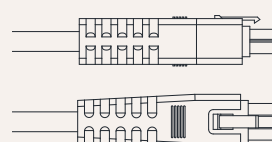

6 = Six-pin straight plug

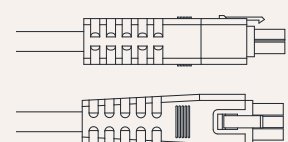

HTW76 Attachment Description Selection Code Table

Tail lower end form:

O1 = No slot, aperture 12.5mm

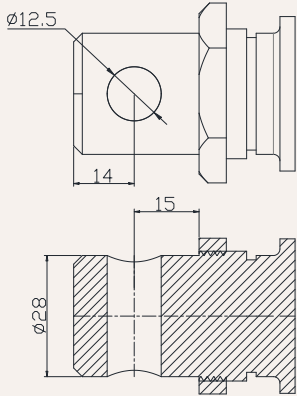

O2= No slot, aperture 13.5mm

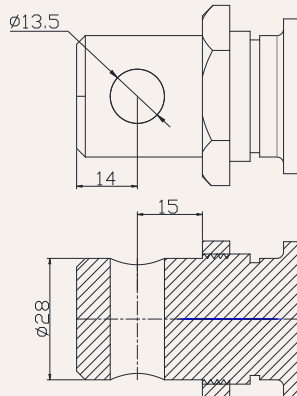

U1 = U-shaped, groove width 10.5mm, hole diameter 12.5mm

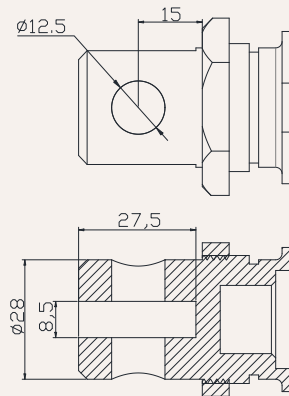

U1 = U-shaped, groove width 10.5mm, hole diameter 13.5mm

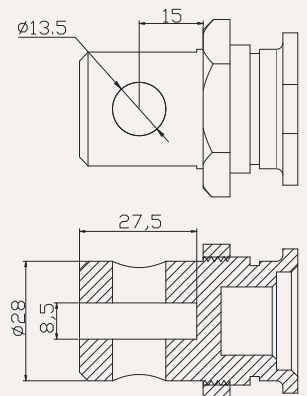

M1= Type M, M16 thread, depth 25 mm

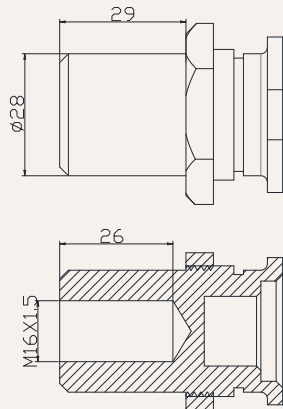

M2= Type M, M18 thread, depth 25 mm

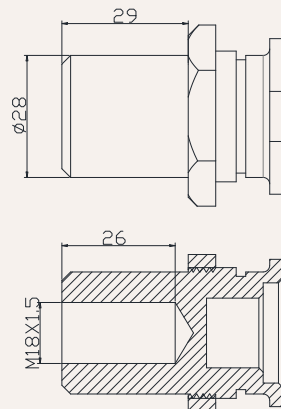

T1 = T-type, M16 thread, length 24mm

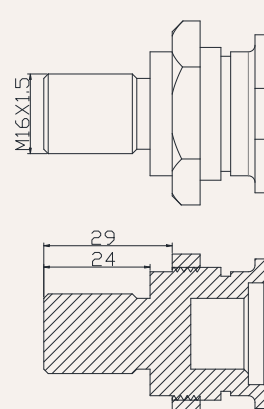

T1 = T-type, M18 thread, length 24mm

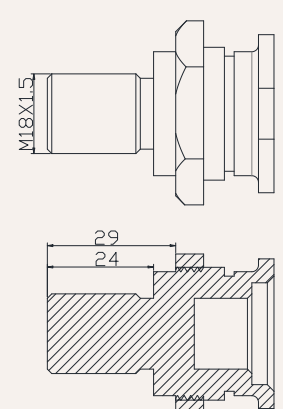

L1 = L shape, width 20mm, aperture 12.5mm

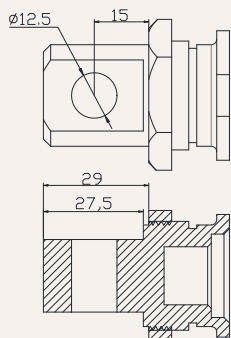

L1 = L shape, width 20mm, aperture 13.5mm

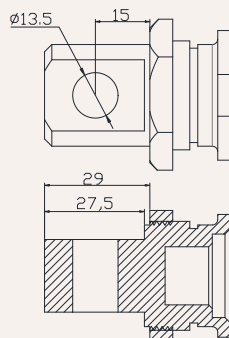

G4 = Spherical bearing, bore 14mm, model GS14

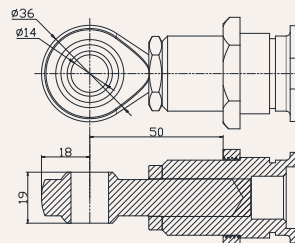

G6 = Spherical bearing, bore 16mm, model GS16

